

6" SUCTION
ANSI#125

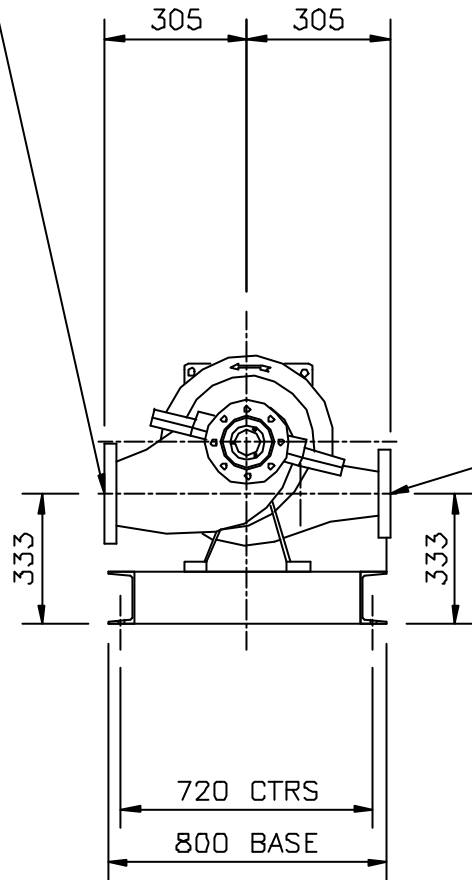

5" DISCHARGE
ANSI#125

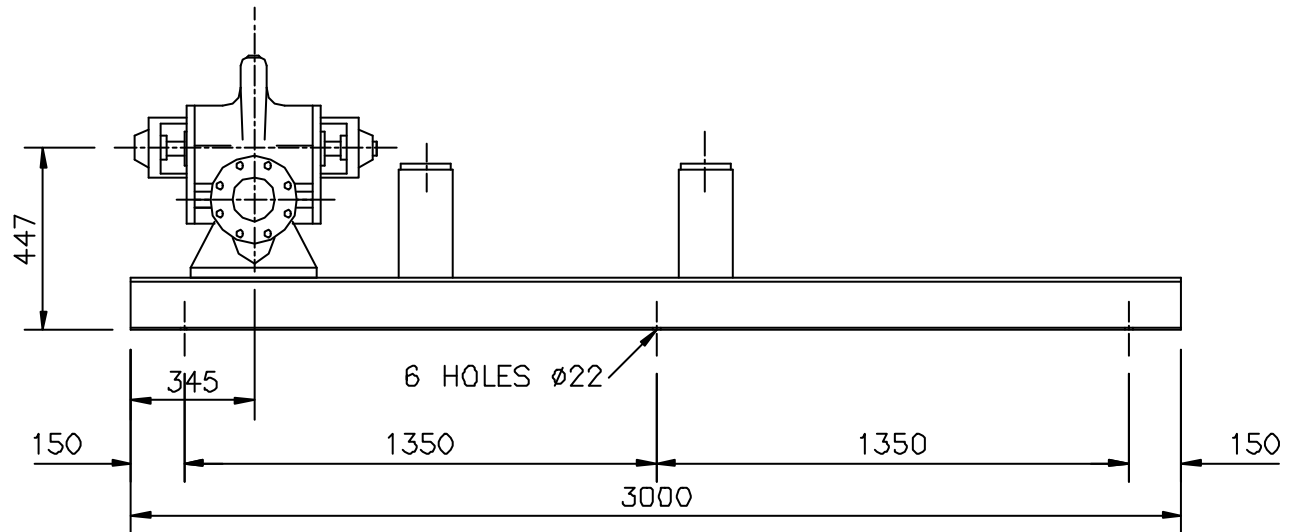

Third Angle Projection

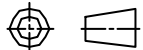

All dimensions in millimetres
unless otherwise stated

Tolerances
(general)

Linear ± 0.5
Angular $\pm 0.5^\circ$

F			
E			
D	8245	08DEC99	NGS
C	8178	22FEB99	NGS
B	8141	25AUG98	NGS
A	8121	22MAY98	NGS
REV	ECD No	DATE	SIGN

ARMSTRONG PUMPS LTD

COLCHESTER ESSEX UK

SCALE NTS	DATE 22MAY98
DETAIL NAME 08213-1	CHECKED

© ARMSTRONG PUMPS LIMITED
This drawing is not to be used for general
production unless with an original (red)



except when production order
specifies drawing no. & revision letter.

Material
NA
Structural sections to BS4 part 1
Hollow sections to BS4B48 part 2

TITLE
DIESEL FIRE PUMP 6x5x10
UNLISTED LPC BUILDERS SHEET

DRAWING NUMBER
UKD08213 SHT 1 OF 3

A3

DRAWN
NGS